

# A3 INSTALLATION DRAWING

If this document is printed in hardcopy, it is for information only and therefore is not subject to updating controls. Always refer to viewer for latest issue



FIRST ANGLE PROJECTION

THIS DRAWING IS CONFIDENTIAL AND IS SUPPLIED ON THE EXPRESS CONDITION THAT IT SHALL NOT BE LOANED OR COPIED OR DISCLOSED TO ANY OTHER PERSON OR USED FOR ANY OTHER PURPOSE WITHOUT THE WRITTEN CONSENT OF AP RACING LTD.



AP Racing  
 Wheler Road  
 Coventry  
 CV3 4LB  
 Tel: +44 024 7663 9595  
 Fax: +44 024 7663 9559  
 e-mail: engineering@apracings.co.uk  
 web-site: HTTP://www.apracings.com

Issue No.	Alterations		Zone	Initials
	Date & No.	Particulars		
1	02/08/07 B4932	FIRST ISSUE		SAT
2	18/03/14 B7044	STRIPE COLOUR & BORE SIZE ADDED TO SEAL DETAILS		SAT

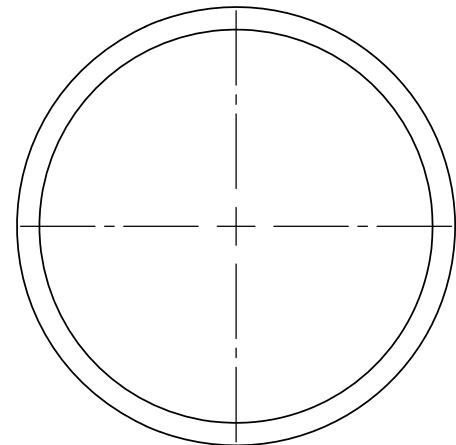

CP4900-160  
 1 RED STRIPE  
 BORE N - 2.00"

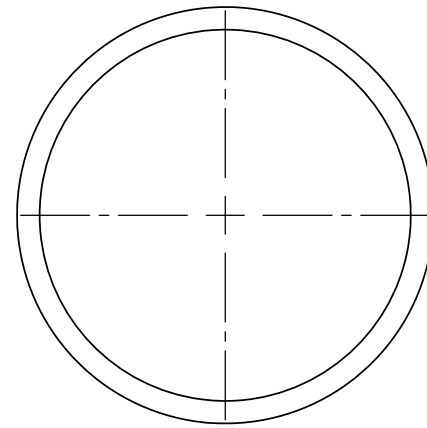

CP4900-161  
 2 RED STRIPE  
 BORE M - 1.87"

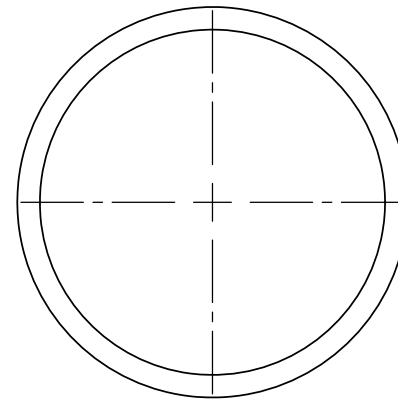

CP4900-162  
 3 RED STRIPE  
 BORE L - 1.75"

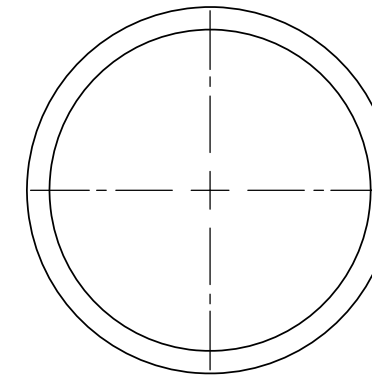

CP4900-163  
 1 RED STRIPE  
 BORE K - 1.62"

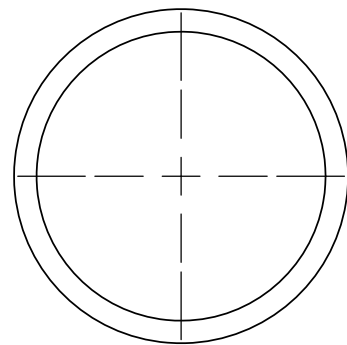

CP4900-164  
 2 RED STRIPE  
 BORE J - 1.50"

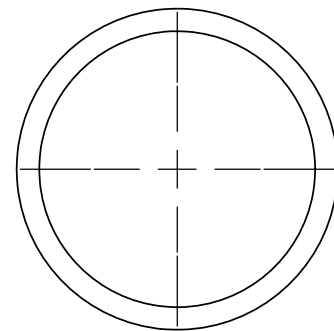

CP4900-165  
 3 RED STRIPE  
 BORE H - 36mm

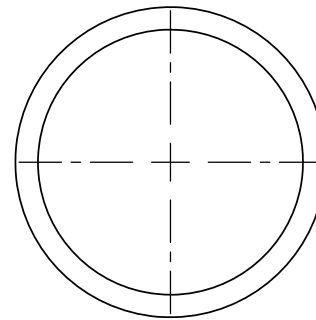

CP4900-166  
 1 RED STRIPE  
 BORE G - 1.37"

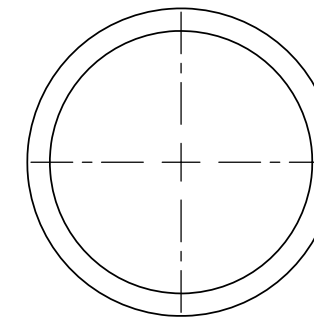

CP4900-167  
 2 RED STRIPE  
 BORE F - 34mm

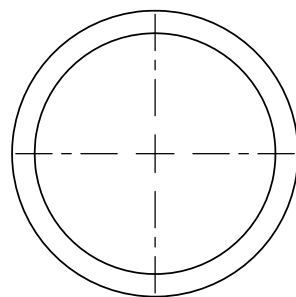

CP4900-168  
 3 RED STRIPE  
 BORE E - 1.25"

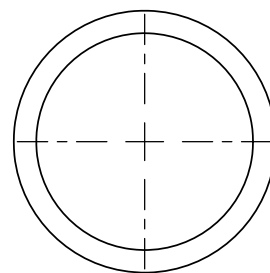

CP4900-169  
 1 RED STRIPE  
 BORE D - 1.12"

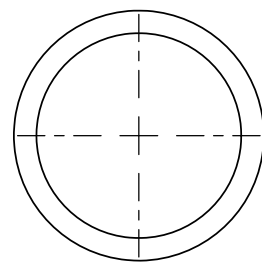

CP4900-170  
 2 RED STRIPE  
 BORE C - 1.06"

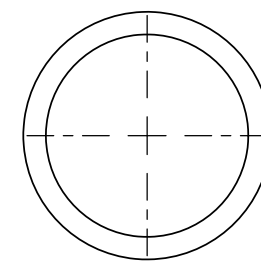

CP4900-171  
 3 RED STRIPE  
 BORE B - 26mm

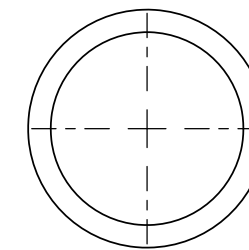

CP4900-172  
 1 RED STRIPE  
 BORE A - 1.00"

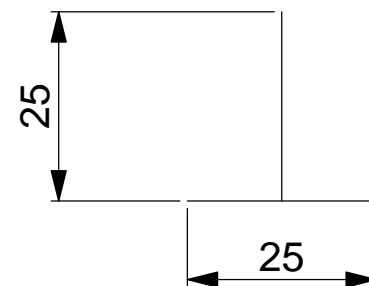

ALL VIEWS ARE 1:1 PRINT 100% SCALE TO CHECK SEALS AGAINST DRAWING

SCALE 1:1

SHEET 1 OF 1

DRAWN	Steve Thomas
APPROVED	#
DERIVED FROM	
TITLE HI TEMP SEAL KIT HIGH TEMP. SPEC SEAL IN BORE	
Drg No.	CP4900-13CD